

[CONTRIBUTION FROM THE CHEMICAL LABORATORY OF DUKE UNIVERSITY]

**Elimination and Metathetical Reactions and the Electronic Theory of Rearrangements**

BY CHARLES R. HAUSER

Various workers have attempted to formulate general mechanisms for elimination, metathetical and intramolecular rearrangement reactions, which are characteristic of many compounds containing an electronegative atom or group, X (such as halogen or hydroxyl). In 1928 Ingold and Shoppee<sup>1</sup> pointed out that the fundamental type of electronic change underlying a number of apparently diverse rearrangements is the same. They represented these changes according to the following scheme, in which A, D and E are atoms of carbon, nitrogen or oxygen



In 1932 Whitmore<sup>2</sup> formulated a more comprehensive and detailed theory for eliminations, metatheses and intramolecular rearrangements. The essential feature of the theory is that X is removed with a complete octet of electrons, leaving an atom with only a sextet of electrons. The positive fragment thus formed may add an anion, lose a proton or undergo rearrangement (involving the shift of an electron pair together with R attached) to form a new positive fragment which may undergo these changes.

While these generalizations account for the products (both "normal" and rearranged) that are formed in certain reactions effected by acidic reagents<sup>3</sup> or heavy metal salts,<sup>4</sup> it is now recognized that the theory requires modification. Evidence has been presented that at least in certain metatheses<sup>5</sup> and in a pinacol type of rearrangement<sup>6</sup> (in which a molecule of water is eliminated) an atom with an "open" sextet is probably not actually formed as an intermediate.

For the purpose of predicting products it is

(1) Ingold and Shoppee, *J. Chem. Soc.*, 365 (1928); Ingold, *J. Chem. Soc. Annual Reports*, **25**, 133 (1928); also, see Baker, "Tautomerism," Routledge, London, 1934, pp. 276-309.

(2) (a) Whitmore, *THIS JOURNAL*, **54**, 3274 (1932); (b) Whitmore and Fleming, *J. Chem. Soc.*, 1269 (1934); also, see Wallis in Gilman "Organic Chemistry," John Wiley and Sons, New York, N. Y., 1938, pp. 778-801.

(3) See Whitmore and Langlois, *THIS JOURNAL*, **54**, 3441 (1932); also, see ref. 2a.

(4) See ref. 2b and Whitmore, Wittle and Popkin, *ibid.*, **61**, 1588 (1939).

(5) See, for example, Johnson in Gilman "Organic Chemistry," John Wiley and Sons, New York, N. Y., 1938, p. 1633.

(6) Bartlett and Pockel, *THIS JOURNAL*, **59**, 820 (1937); see also Bernstein and Whitmore, *ibid.*, **61**, 1324 (1939).

generally adequate to describe the general courses of reactions, rather than to give detailed mechanisms. The roles of reagents used to effect reactions should be taken into account, and, for convenience, the course may be represented in steps. The courses of eliminations, metatheses and intramolecular rearrangements effected by means of acids, acidic reagents or heavy metal salts (or in certain cases by heat alone) may be described by the generalizations outlined by Whitmore (with the modification that the steps may occur simultaneously). These reactions may be initiated (or facilitated) by an attack of the reagent on X,<sup>7</sup> which is removed with its bonding pair of electrons. The course of elimination of HX involves the removal of X, with or without rearrangement of the molecule, accompanied or followed by the loss of a proton. Metatheses in the presence of these reagents may involve the primary removal of X, or might follow the course outlined in the next paragraph.

Metathetical reactions with basic anions, for example, the alkaline hydrolysis of alkyl halides, may be considered to involve an attack by the anion on the face of the carbon tetrahedron which is opposite X, the addition of the basic anion and the release of X as an anion occurring simultaneously (and being accompanied by the Walden inversion).<sup>8</sup>

Elimination reactions in which HX is removed by bases, probably involve a primary attack on the hydrogen, even when it is attached to a carbon atom. It is obvious that when a base is used to remove HX from a distinct acid, for example, trichloroacetic acid (where X is CCl<sub>3</sub>) or a bromoamide, the hydrogen is first withdrawn as a proton, and evidence has been presented by Ingold,<sup>9</sup> Olivier<sup>10</sup> and others<sup>11</sup> that in the elimination of HX from the adjacent atoms of alkyl halides<sup>10</sup> or certain other compounds, the reaction is initiated

(7) In this connection, see Roberts and Hammett, *ibid.*, **59**, 1063 (1937); Ayers, *ibid.*, **60**, 2957 (1938); see also ref. 6, p. 821.

(8) For recent references to the Walden inversion see ref. 5 and Bartlett and Knox, *ibid.*, **61**, 3184 (1939).

(9) See especially, Ingold, Hughes and co-workers, *J. Chem. Soc.*, 1177-1291 (1937), and earlier papers; Taylor, *ibid.*, 343, 1962 (1937); Watson, *J. Chem. Soc., Ann. Repts.*, **35**, 226 (1938).

(10) Olivier, *Rec. trav. chim.*, **53**, 1093 (1934).

(11) See Hauser, LeMaistre and Rainsford, *THIS JOURNAL*, **57**, 1056 (1935).

by an attack on the hydrogen atom. The remainder of this paper is devoted to the development of these ideas.

**The Removal of HX from Organic Compounds by Means of Bases.**—In this paper it is assumed as a working hypothesis that most organic compounds from which HX is removed by means of bases to form unsaturated products (or, in certain cases, cyclic products) function as acids, and that the primary acid–base reaction conditions subsequent changes that may occur. For convenience, the general course of these elimination reactions may be divided into three steps. First, the hydrogen is removed as a proton; second, X is released with a complete octet of electrons (*i. e.*, as an anion); and third, the molecule is stabilized. While intimate mechanisms may differ, most eliminations effected by bases may be considered to follow this general course.<sup>12</sup>

The first step is regarded as an acid–base reaction according to the modern conception of acids and bases. The extent to which this reaction may occur independently of subsequent changes should depend upon the acidic strength of the organic compound, the solvent, and the strength of base used. For a given base and solvent, the equilibrium of the acid–base reaction will of course be determined by the acidic strength of the organic compound. Two extreme types of reaction would be type I, in which the equilibrium of the acid–base reaction is far on the side of corresponding salt, and type II, in which the equilibrium of the acid–base reaction would be far on the side of the original acid and base. An example of type I is the reaction of alkali with a distinct acid, such as trichloroacetic acid, or even a bromoamide, and an example of type II is the reaction of this base with an extremely weak acid, such as an alkyl halide or a compound of the type  $RCH=NX$ . Although these types exhibit different kinetics, both may be classified according to the general course outlined above. It should be pointed out that in reactions of type I, steps (2) and (3) may occur simultaneously, while in reactions of type II, all three steps may be simultaneous and dependent on one another.

It has been shown that at least in certain cases reactions of type I exhibit monomolecular

(12) In certain cases in which the hydrogen is relatively unreactive, and X relatively easily released as an anion, it is possible that X might be removed first followed by the loss of the proton, even in the presence of a base. In this connection see *J. Chem. Soc., Ann. Repts.*, **35**, 226 (1938).

kinetics, the reaction measured presumably being the decomposition of the negative organic ion<sup>13</sup> of the salt which is formed by the removal of the proton. The rate of decomposition of the negative organic ion, even though rearrangement occurs, in general appears to be dependent upon the anionic stability (or the “negativity”) of X and on the capacity for electron release of the remainder of the molecule. Thus, for example, in the decomposition<sup>14</sup> of negative organic ions of the type

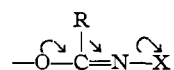

the order of increasing rate (as well as the order of increasing anionic stability of X) when R is phenyl and X is varied is as follows:  $p\text{-CH}_3\text{OC}_6\text{H}_4\text{COO} < \text{HC}_6\text{H}_4\text{COO} < m\text{-FC}_6\text{H}_4\text{COO} < m\text{-NO}_2\text{C}_6\text{H}_4\text{COO}$ ; while the order of decreasing rate (as well as the order of decreasing capacity for electron release of R) when X is benzoate or bromine and R is varied is as follows:  $p\text{-CH}_3\text{OC}_6\text{H}_4 > \text{HC}_6\text{H}_4 > m\text{-ClC}_6\text{H}_4 > m\text{-NO}_2\text{C}_6\text{H}_4$ .

Most reactions of type II, at least when HX is removed from adjacent atoms, exhibit bimolecular kinetics, the rate of elimination of HX being dependent upon the “activity” of the hydrogen and the strength of base used. Thus, hydrogen bromide is removed by alkali two hundred times faster from ethylene dibromide than from ethylidene bromide,<sup>10</sup> and in the series of para substituted benzalchlorimines,  $Y\text{-C}_6\text{H}_4\text{CH}=\text{NCl}$ , the rates of elimination of hydrogen chloride by alcoholic alkali are directly related to the strengths of the corresponding carboxylic acids.<sup>11</sup>

Since the rates of elimination of HX from adjacent atoms of compounds of type II are related to the activities of the hydrogen, it might appear that the removal of the proton is the rate determining step of the reaction,<sup>15</sup> but it might also be possible for the rate determining step to be the release of X as an anion from the negative organic ion that would be formed by the removal of the proton. Since the equilibrium of the acid–base

(13) The decomposition of the trichloroacetate ion exhibits monomolecular kinetics. The reaction gives carbon dioxide and presumably the ion  $(\text{CCl}_3)^-$  which immediately takes up a proton from the solvent forming chloroform; Verhoek, *THIS JOURNAL*, **56**, 576 (1934).

(14) See Renfrow and Hauser, *ibid.*, **59**, 2308 (1937); Hauser and Renfrow, *ibid.*, **59**, 121 (1937); Bright and Hauser, *ibid.*, **61**, 618 (1939).

(15) The reactions of certain extremely weak acids (in which the acidic hydrogen is attached to carbon) with bases, are slow enough to measure; Conant and Wheland, *ibid.*, **64**, 1212 (1932).

reaction would be far on the side of the original base and extremely weak acid, the concentration of the negative organic ion should be dependent upon the concentrations of both the base and the acid. The fact that the rate is directly related to the activity of the hydrogen rather than the ease of release of X, as in reactions of type I, might be accounted for on the basis that the activating atom or group, for example, the para substituent of a benzalchlorimine, activates the hydrogen relatively more than it retards the release of chloride ion.

According to the generally accepted view of elimination of HX from the adjacent atoms of many compounds of the type II, the removal of the proton and the release of X are regarded as essentially simultaneous processes. A more detailed mechanism for the elimination of hydrogen halide from alkyl halides may be represented as follows

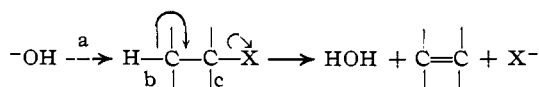

As bond a is being formed, bonds b and c are extended and finally broken simultaneously, the electron pair from bond b shifting at the same time to form the double bond. In this way a minimum of energy would probably be required for the elimination reaction.

Although the complete withdrawal of the proton may be accompanied by the simultaneous release of X as an anion, the alkyl halide may still be regarded as an acid in a broad sense; the elimination appears to involve a primary attack by the base on the "active" hydrogen atom, the shift of the electron pair and the release of X being dependent<sup>16</sup> upon this primary reaction. Regardless of the intimate mechanism involved, the base apparently conditions the reaction so that its course may be described by the steps outlined above.

The second step of the general course, involving the release of X with a complete octet of electrons, would leave an atom with only a sextet of electrons; this makes it possible for an electronic shift to occur within the molecule. If there is a free pair of electrons on an atom adjacent to the one from which X was released, this pair may shift to form a double (or triple) bond between

(16) The reaction appears to be dependent also on the polarizability of X, since the ease of elimination of hydrogen halide from alkyl iodides, bromides and chlorides decreases in this order. In this connection see Taylor, *J. Chem. Soc.*, 1962 (1937).

the two atoms, thereby stabilizing the molecule; thus  $\begin{array}{c} \curvearrowright \\ | \\ \text{---A---D} \\ | \quad | \end{array} \longrightarrow \begin{array}{c} \text{A}=\text{D} \\ | \quad | \end{array}$ . But if there is no free pair of electrons on atom A, the deficiency of atom D may be satisfied by a shift of an electron pair together with group R (or hydrogen) attached from atom A to atom D, thus

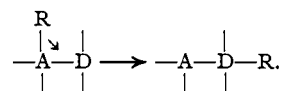

This rearrangement may involve inversion (Walden) of atom D. The migration of the electron pair (together with R) from atom A to atom D would leave atom A with only a sextet of electrons, a deficiency which may be satisfied by a shift of a free pair of electrons from atom D, or from another atom E, adjacent to atom A, to form a double (or triple) bond thus

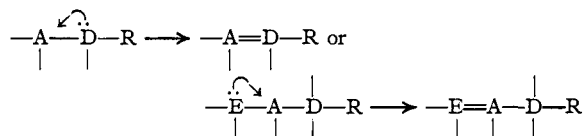

From the foregoing discussion one should expect that when the proton is removed by a base, followed by the release of X (with a complete octet of electrons) from an *adjacent* atom, no rearrangement should occur, since the molecule can be stabilized merely by the shift of the free pair of electrons (left by the removal of the proton) to form a double or triple bond<sup>17</sup>; the shift of a free pair of electrons in this manner should take place more readily than a shift of an electron pair together with hydrogen or group R attached from one atom to another. On the other hand, if the proton and X are eliminated from the same atom or from a three atom system, rearrangement may be expected. It is noteworthy that although the removal of the proton cannot in itself bring about a rearrangement, the primary acid-base reaction plays an important role in determining whether or not rearrangement will occur.

It may be considered that the manner in which the molecule is stabilized, the third step of the general course, depends upon the system from which HX is removed. This is based of course on obvious valency requirements and may be illustrated by the equations listed below, in which A, D and E represent atoms of carbon, nitrogen, or oxygen. Steps (1) and (2) are combined for

(17) See Hauser and Jordan, *THIS JOURNAL*, 57, 2454 (1935).

simplicity with step (3) shown separately, but this representation is to be regarded merely as a formal scheme which is an aid in predicting products. It should be noted, also, that as far as the prediction of products is concerned, there need be no distinction between reactions of types I and II.

When HX is removed (by a base) from the same atom, the molecule may be stabilized by the formation of unsaturated products (a), by rearrangement, or (b) by dimerization.

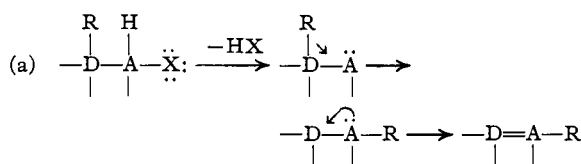

Examples:

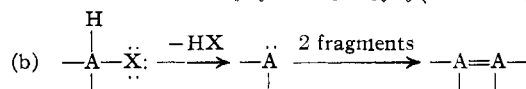
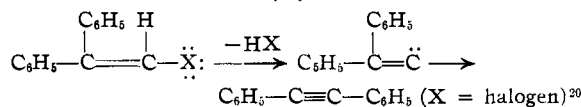
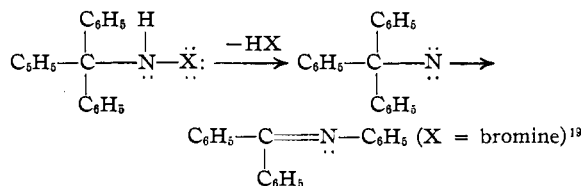
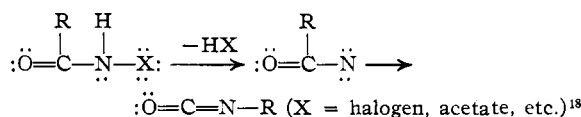

Example:

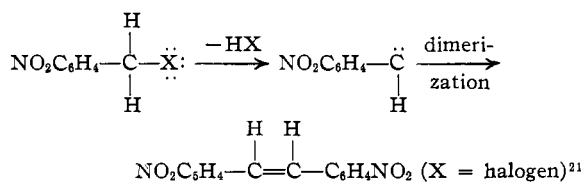

A special case arises when HX is removed from the same atom, adjacent to which there is an atom with a free pair of electrons. Then it is

(18) In the Hofmann and Lossen reactions HX may be considered to be removed from a one or a three-atom system (see ref. 14).

(19) Stieglitz and Vosburgh, *Ber.*, **46**, 2151 (1913).

(20) Coleman and co-workers [*THIS JOURNAL*, **56**, 132 (1934); *ibid.*, **58**, 2310 (1936)] have found that with potassium amide in liquid ammonia diarylhaloethenes give good yields of tolans.

(21) Ortho and para nitrobenzyl halides with alcoholic alkali give partly the corresponding dinitrostilbenes. See Michael, *ibid.*, **42**, 820 (1920). It should be noted that in these cases rearrangement is not possible.

theoretically possible for the molecule to be stabilized, in accordance with the octet rule, merely by a shift of the free electron pair, without involving rearrangement of the molecule; in this case, however, one atom becomes positively, and the adjacent one negatively, charged. This might occur in the formation of isonitriles from primary amines, chloroform and alkali. According to the mechanism frequently assumed for this reaction the intermediate,  $\text{RN}=\text{CHCl}$ , is formed. This could eliminate HCl followed by the shift of the free electron pair on the nitrogen atom, thus:

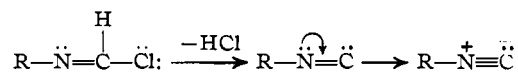

Recent evidence supports this structure for isonitriles. The fact that isonitriles when heated<sup>22</sup> rearrange to nitriles, indicates that the molecule can become more stable by the migration of R together with its electron pair to form the less polar nitrile.

When HX is removed (by a base) from adjacent atoms, the molecule may be stabilized by the formation of unsaturated products without rearrangement; the stabilization involves merely the shift of the free pair of electrons, left by the removal of the proton, to form a double or triple bond; thus

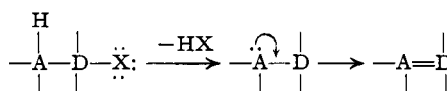

Examples:

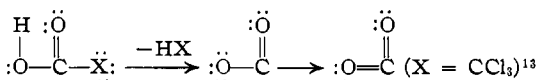
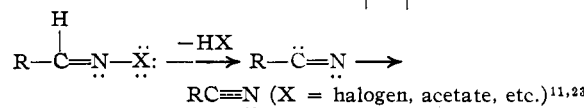
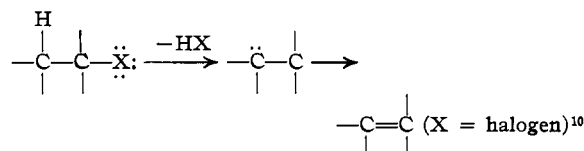

When HX is removed (by a base) from a three-atom system the molecule may be stabilized, (a)

(22) See Hurd, "The Pyrolysis of Carbon Compounds," The Chemical Catalog Co., New York, N. Y., 1929, p. 603.

(23) The geometrical configuration of these compounds determines the ease with which the elements of HX will be eliminated, the *anti*-isomers eliminating HX much more readily than the *syn*-isomers (see especially ref. 17).

by the formation of unsaturated products involving rearrangement of the molecule, or (b) by cyclization

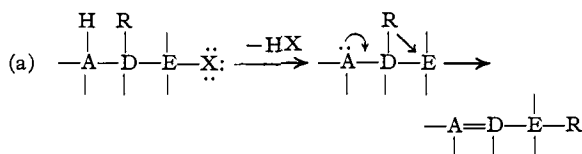

Examples:

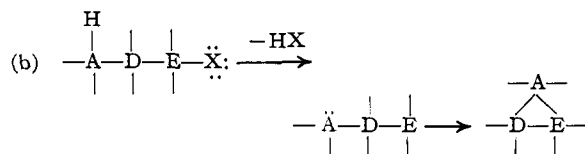
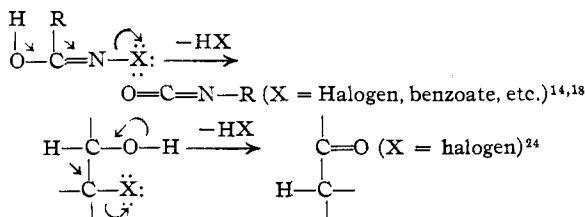

Example:

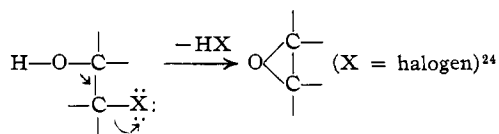

When HX is removed (by a base) from a four-atom system the molecule may be stabilized (a) by the formation of two unsaturated products without rearrangement, or (b) by cyclization. Examples in which two unsaturated products are formed without rearrangement may be represented as follows

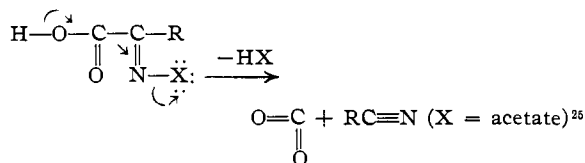
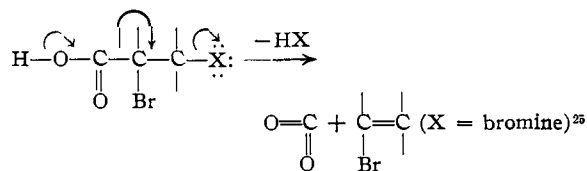

(24) Apparently, on elimination of HX, *cis*-halohydrins undergo rearrangement, while *trans*-halohydrins cyclize giving ethylene oxide rings. See Suter and Lutz, *THIS JOURNAL*, **60**, 1360 (1938); Winstein and Lucas, *ibid.*, **61**, 1576 (1939); Bartlett, *ibid.*, **57**, 224 (1935).

(25) See Bachman, *ibid.*, **55**, 4279 (1933).

(26) Hantzsch, *Ber.*, **24**, 45 (1891).

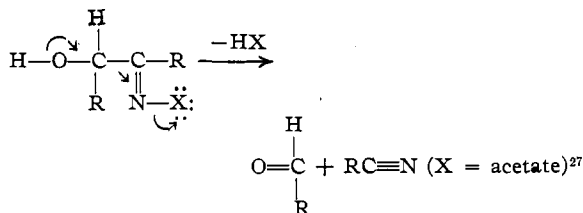

These systems might be "double" two atom systems in which case the decomposition of the anion (formed by the removal of the proton) could be represented as follows:

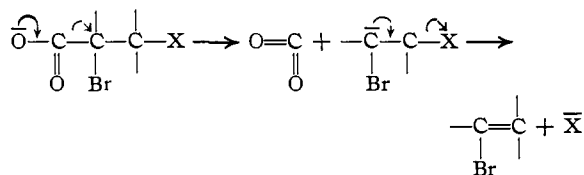

When HX is removed (by a base) from five and six atom systems, the molecules are generally stabilized by cyclization. It should be pointed out that these reactions may or may not involve the primary removal of the hydrogen as a proton. The elimination of HX from acids, for example,  $\gamma$ -bromobutyric acid,<sup>28</sup> in the presence of alkali (where the acid-base reaction is of type I) obviously involves, first, the removal of the hydrogen as a proton to form the alkali salt, followed presumably by the release of bromide ion and cyclization to give  $\gamma$ -butyryl-lactone. But the elimination of HX from weaker acids, for example, 4-bromobutylamine,  $\text{BrCH}_2\text{CH}_2\text{CH}_2\text{CH}_2\text{NH}_2$ , in the presence of alkali, apparently does not involve the primary removal of the hydrogen as a proton, since the reaction is not dependent upon the concentration of the base. In these cases the elimination of hydrogen halide is facilitated by the presence of the base apparently because it neutralizes the acid that is formed in the elimination, thereby preventing the reverse reaction (*e. g.*, opening of the ring). The mechanism for these eliminations has been discussed by Salomon.<sup>29</sup>

In the examples listed above and in others, the formation of unsaturated products involves rearrangement of the molecule (except in cases of dimerization) when HX is removed by a base from one or three atom systems, but no rearrangement when HX is removed by a base from two

(27) See Blatt and co-workers, *THIS JOURNAL*, **56**, 1148 (1934); **57**, 1330 (1935).

(28) See Caldin and Wolfenden, *J. Chem. Soc.*, 1239 (1936).

(29) Salomon, *Trans. Faraday Soc.*, **32**, 153 (1936).

or four atom systems.<sup>30</sup> These facts support the general theory discussed in this paper.<sup>31</sup>

In most of the examples listed above, the organic compound can eliminate the elements of HX only from one particular system of atoms. There are many compounds, however, which might eliminate HX in two or more ways; for example, a compound of the type  $\begin{array}{c} \text{H} \quad \text{H} \\ | \quad | \\ \text{A}-\text{D}-\text{X} \end{array}$  might eliminate the elements of HX either from the same atom (accompanied by rearrangement or dimerization) or from adjacent atoms. In these cases it has frequently not been possible to determine with certainty which course is followed,<sup>32</sup> since the same unsaturated product could be formed by either course; thus, the elimination of HX from atom D, accompanied by a shift of the hydrogen (together with its electron pair) from atom A to atom D would give an unsaturated product identical with the one resulting from the elimination of HX from the adjacent atoms A and D.

Most recent workers have assumed that with alkyl halides of the type  $\begin{array}{c} \text{H} \quad \text{H} \\ | \quad | \\ -\text{C}-\text{C}-\text{X} \\ | \quad | \end{array}$ , the hydrogen halide is removed by bases from adjacent atoms<sup>33</sup> without rearrangement of the molecule, and although there are statements in the literature to the contrary,<sup>34</sup> it now appears that at least the olefins formed from simple alkyl halides may be accounted for on this basis. Olivier<sup>10</sup> lists a num-

(30) Whether or not this is true in all cases remains of course to be determined by experiment. An apparent exception has been reported by Werner and Piguet, *Ber.*, **37**, 4295 (1904); Werner and Detschew, *ibid.*, **38**, 69 (1905). These workers reported that  $\beta$ -benzoin-oxime or  $\beta$ -benzilmonoxime when heated with benzenesulfonyl chloride and alkali give partly phenyl isocyanide, which is a rearrangement product. Evidence has been obtained in this Laboratory, however, that the rearrangement is effected merely by heat rather than by the action of the base. These results will be published shortly.

(31) Ingold and co-workers have shown that in the decomposition of quaternary ammonium compounds to form unsaturated products, the removal of HNR<sub>3</sub> from the same atom of the positive ion ( $\alpha$ -hydrogen elimination) is accompanied by dimerization, and the removal of HNR<sub>3</sub> from a three-atom system ( $\gamma$ -hydrogen elimination) is accompanied by rearrangement; whereas the removal of HNR<sub>3</sub> from adjacent atoms ( $\beta$ -elimination) forms unsaturated compounds without dimerization or rearrangement. See Ingold and Rogers, *J. Chem. Soc.*, 722 (1935).

(32) It is of interest to note that the substitution of certain hydrogen atoms by deuterium might serve to give positive data concerning the course followed. This study is being carried out in this Laboratory.

(33) In this connection see Watson, *J. Chem. Soc., Ann. Repts.*, **35**, 226 (1938); also, see ref. 10.

(34) It has been stated, for example, that isobutyl halides with alcoholic alkali give both *n*-butylene and isobutylene; see Francis, "Notes on Organic Chemistry," Edward Arnold and Company, London, 1935, p. 182.

ber of alkyl halides and related compounds which, when treated with bases, give unsaturated products that could be formed without rearrangement. Chablay<sup>35</sup> has reported that isobutyl halides with sodamide in liquid ammonia give the expected isobutylene. Recently, Whitmore and co-workers have made a careful search for all products formed from certain alkyl halides and hot alcoholic alkali. They found<sup>36</sup> that *n*-butyl iodide gives butene-1 and *n*-butyl ethyl ether, while isoamyl iodide gives 3-methyl-butene-1 and isoamyl ethyl ether; no other olefins were obtained. The ethers were formed presumably by substitution reactions. Since the olefins may be accounted for on the basis that the elements of hydrogen iodide were eliminated from adjacent carbon atoms, they may be regarded as "unrearranged" products; however, it should be remembered that the same olefins would have resulted if the elements of hydrogen iodide were removed from the same carbon atom, and the elimination accompanied by the shift of a hydrogen from an adjacent carbon atom.

In contrast to the results discussed above, Amagat<sup>37</sup> has reported that certain phenylalkyl-ethyl bromides when heated with sodamide in boiling xylene (b. p. 140°) give rearranged olefins. Under these conditions, bromides of type (I), in which R is methyl, ethyl or isopropyl

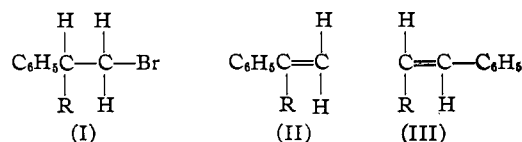

were reported to give almost exclusively olefin (III), the formation of which would obviously involve rearrangement of the molecule.

On repeating this experiment in this Laboratory<sup>38</sup> using potassium amide instead of sodamide, we have found that the bromide in which R is ethyl, although giving some of olefin (III), also gives approximately an equal amount of olefin (II). It has been found, furthermore, that when the reaction is carried out with potassium amide in liquid ammonia (b. p. -33°), the bro-

(35) Chablay, *Compt. rend.*, **156**, 327 (1913); see Bergstrom and Fernelius, *Chem. Rev.*, **12**, 92 (1933).

(36) Whitmore, Wittle and Flinn, reported at the Pittsburgh meeting of the American Chemical Society, September, 1936.

(37) Amagat, *Bull. soc. chim.*, **49**, 1410 (1931).

(38) These results were presented by Hauser, Bright and Renfrow before the division of organic chemistry at the Boston meeting of the American Chemical Society, September, 1939. These results will be published soon.

imide (in which R is methyl or ethyl) gives almost entirely olefin (II).<sup>38</sup> The formation of this olefin has been assumed to involve the elimination of hydrogen bromide from adjacent carbon atoms without rearrangement, but it is possible that hydrogen bromide was removed from the same carbon atom, accompanied by the shift of the hydrogen atom.

The formation of olefin (III) under the more drastic conditions (at 140°) might have involved the removal of hydrogen bromide from the same carbon atom, accompanied by the shift of the phenyl group or of R; or the reaction might have consisted of a thermal decomposition in which the base functioned merely to neutralize the hydrogen bromide eliminated.

It has been reported<sup>39</sup> that ethylchloroamine when warmed with alcoholic alkali and the mixture treated with excess hydrochloric acid, gives acetaldehyde, formaldehyde and methylamine. While the acetaldehyde could have been formed without rearrangement (by hydrolysis of acetaldehyde-imine which would be formed if the elements of hydrogen chloride were eliminated from adjacent atoms), the formation of formaldehyde and methylamine would necessarily involve a rearrangement of the molecule. These compounds may be accounted for on the basis that the elements of hydrogen chloride were removed from the same atom (nitrogen) and the elimination was accompanied by a shift of the methyl group to give formal-methylamine, which subsequently underwent hydrolysis; the acetaldehyde also could be accounted for on this basis, by assuming the shift of the hydrogen atom. Since the hydrogen attached to the nitrogen of the ethylchloroamine is much more active (acidic) than the hydrogen on the adjacent carbon atom, one might expect that the elements of HX would be removed from the same atom (nitrogen).

The reactions of bases with compounds containing the carbonyl (or similar) group require special consideration. Simple aldehydes and ketones are relatively stable toward alkali, but negatively substituted derivatives, for example,  $\text{CCl}_3\text{CHO}$  or  $\text{CCl}_3\text{COCH}_3$ , are readily cleaved by this reagent. Since these compounds form hydrates,<sup>40</sup> the reaction with aqueous alkali may

(39) See Franklin, "Nitrogen System of Organic Compounds," A. C. S. Monograph 68, Reinhold Publishing Corp., New York, N. Y., 1935, pp. 182-183.

(40) See Fuson and co-workers, *THIS JOURNAL*, **52**, 3269 (1930), and later papers.

be considered to involve the removal of HX, where X is  $\text{CCl}_3$ , from adjacent atoms of the hydrate; thus

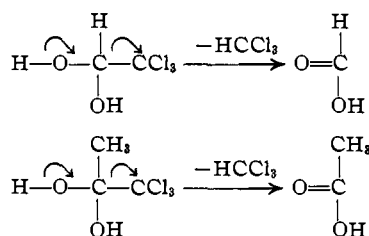

The intermediate negative organic ion that would result if a proton were removed from the hydrate might also be formed by a direct attack of the hydroxyl ion on the carbonyl group of chloral; thus

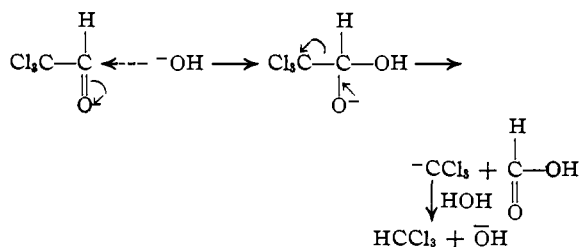

Represented in this manner the haloform reaction becomes analogous to the hydrolysis of esters, amides, anhydrides, acid chlorides, etc. These compounds may be represented by the general formula  $\begin{array}{c} \text{R}-\text{C}=\text{O} \\ | \\ \text{X} \end{array}$  or  $\begin{array}{c} \text{H}-\text{C}=\text{O} \\ | \\ \text{X} \end{array}$ , where X is an electro-negative atom or group, such as  $\text{OC}_2\text{H}_5$ ,  $\text{NH}_2$ ,  $\text{OCOR}$ ,  $\text{Cl}$ ,  $\text{CCl}_3$ , etc. In the presence of water these carbonyl compounds form hydrates (at least in low concentrations) which may eliminate the elements of HX from adjacent atoms

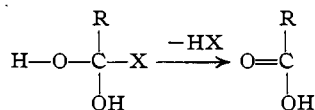

The hydrolysis of compounds of the type  $\begin{array}{c} \text{R}-\text{C}=\text{O} \\ | \\ \text{X} \end{array}$  by means of aqueous alkali apparently involves the intermediate formation of a negative organic ion,<sup>41</sup> which may be formed either by the removal of a proton from the hydrate or by a direct attack of the hydroxyl ion on the carbonyl group; thus

(41) In this connection see Waters and Lowry, "Physical Aspects of Organic Chemistry," D. van Nostrand Company, New York, N. Y., 1936, pp. 236, 267.

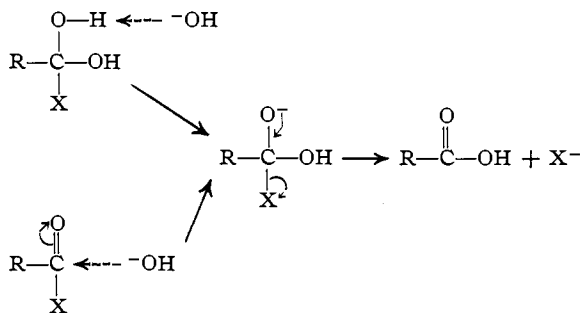

In the compounds considered thus far, X is linked by a single bond. In the elimination of the proton and of X as an anion from such compounds, the covalence of X is decreased one unit. It might be expected that certain compounds containing a relatively negative atom or group X joined by a double or triple bond, as for example, the oxygen in the carbonyl group or the nitrogen in the cyanide group, might give up a proton to a base and "partially" release X, in which the covalence of X likewise decreases one unit; the removal of the proton by a base (B) and the "partial" release of X from adjacent atoms may be illustrated as follows:

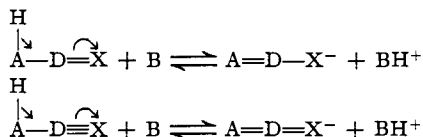

Examples:

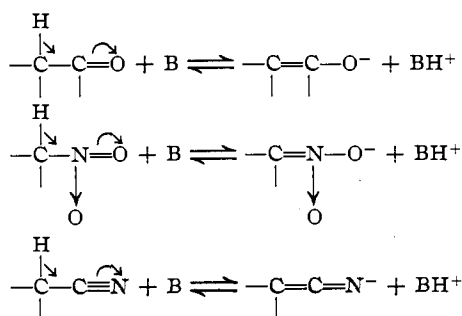

Obviously, these are examples of enolizations of the well-known triad systems<sup>42</sup> in the presence of bases. It should be pointed out that the anions formed in these enolizations are resonance structures; consequently, these examples are not strictly analogous to the elimination reactions discussed in this paper.

In the enolizations in the presence of bases represented above there is a removal of the proton and "partial" removal of X from adjacent

atoms; therefore, no rearrangement should be expected. Similar processes are known, however, in which there is a removal of a proton and a "partial" removal of X from a three-atom system, and in these cases rearrangement takes place. The benzil-benzilic acid rearrangement belongs to this type.<sup>43</sup> Westheimer<sup>44</sup> and Roberts and Urey<sup>45</sup> have presented evidence recently that this rearrangement in the presence of alkali involves the intermediate formation of a negative organic ion. This might be formed either by loss of a proton from the hydrate of benzil or by a direct attack of hydroxyl on benzil. The formation of the intermediate negative ion and its rearrangement to benzilic acid may be represented as follows

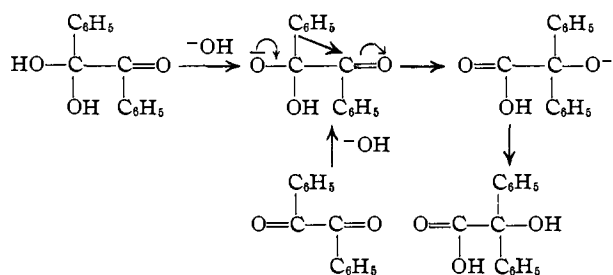

The ideas discussed in this paper are applicable to a number of other apparently diverse eliminations and rearrangements.

Finally, it should be pointed out that the fundamental change that takes place when the elements of HX are removed from organic compounds by means of bases to give unsaturated products may be considered to involve the decomposition of negative organic ions; the latter may exist for an appreciable time as, for example, in the reaction of a bromoamide with alkali, or may have only transient (or no "actual") existence, as in the reaction of an alkyl halide with this base. The negative organic ion is generally formed by the removal of a proton by the action of a base, but in certain cases may be formed by an attack of a basic ion (hydroxyl) on the carbonyl or similar group, as may occur, for example, in the benzil-benzilic acid rearrangement in the presence of alkali. The products formed on decomposition of the negative organic ions may be predicted readily from a consideration of the relative positions of X and the free pair of electrons carrying the negative charge, as illustrated by the following examples

(43) For other examples, see especially ref. 1.

(42) In this connection see, for example, Gilman, "Organic Chemistry," John Wiley and Sons, New York, N. Y., 1938, pp. 1705, 1707.

(44) Westheimer, *THIS JOURNAL*, **58**, 2209 (1936).

(45) Roberts and Urey, *ibid.*, **60**, 880 (1938).



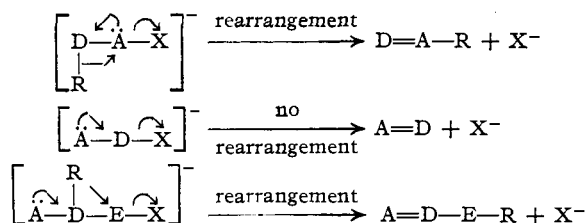

These illustrations are of course essentially the same as those given above where it was considered that the products formed depended upon the system from which HX is removed and, as already pointed out, the molecule may be stabilized in certain cases by dimerization or cyclization instead of by rearrangement.

### Conclusions and Summary

1. General theories are presented for the classification of eliminations, metatheses and rearrangements of compounds containing X, a relatively electronegative atom or group, such as halogen, hydroxyl, etc.

2. Eliminations, metatheses and intramolecular rearrangements effected by acids, acidic reagents and heavy metal salts (electron acceptors) are initiated by an attack of the reagent on X, which is removed with its bonding pair of electrons. The general courses of reaction are described by the generalizations outlined by Whitmore with the modification that the steps may occur simultaneously.

3. Eliminations effected by bases (proton acceptors) are initiated by an attack of the base on the hydrogen. Two extreme types of reactions are considered; in type I, the equilibrium of the primary acid-base reaction is far on the side of the resulting salt, while in type II, the equilibrium of the acid-base reaction is far on the side of the original acid (extremely weak). The general courses of reaction are described by the following steps: The hydrogen is removed as a proton;

X is released with a complete octet of electrons; the molecule is stabilized. In reactions of type I, the second and third steps may be simultaneous processes, while in reactions of type II, all three steps may occur simultaneously. The manner in which the molecule is stabilized depends upon the system from which HX is removed. When HX is removed from the same atom or from a three-atom system, the molecule may be stabilized by rearrangement (or dimerization) giving unsaturated products, whereas when HX is removed from adjacent atoms or a four-atom system, ("double" two-atom system) the molecule may be stabilized by the formation of unsaturated products without rearrangement. When HX is removed from systems containing three or more atoms, the molecule may be stabilized by cyclization.

4. Metathetical (substitution) reactions involving basic anions, for example, the alkaline hydrolysis of alkyl halides, commonly occur side by side with eliminations. In these cases, the anion attacks the carbon at the face of the tetrahedron opposite the position of X, the addition of the anion and the release of X as an anion occurring simultaneously.

5. Certain compounds are considered in which it is possible for HX to be removed by bases in two ways; for example, alkyl halides of the type

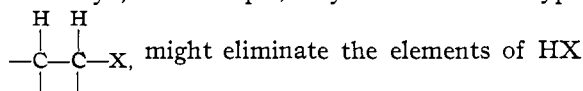

might eliminate the elements of HX either from the same carbon, accompanied by rearrangement or dimerization, or from the adjacent carbon atoms without rearrangement.

6. The reactions of certain carbonyl compounds and their hydrates with bases are discussed in the light of the generalizations presented above.

DURHAM, NORTH CAROLINA

RECEIVED NOVEMBER 24, 1939